



www.slowstop.com

SOFTSTOP[®]

www.softstop.be

SlowStop[®] Rebounding Bollard – Type 2 (SS-T2Y-100)

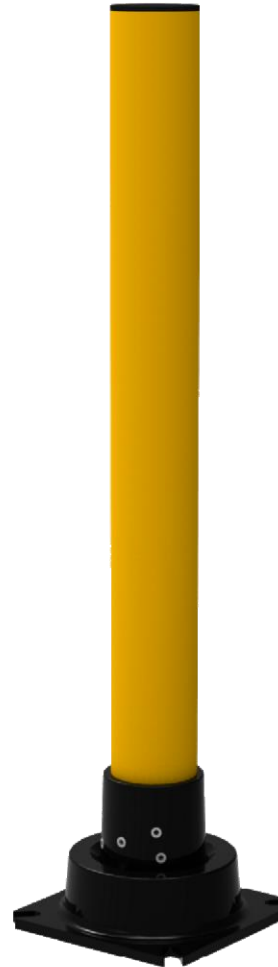
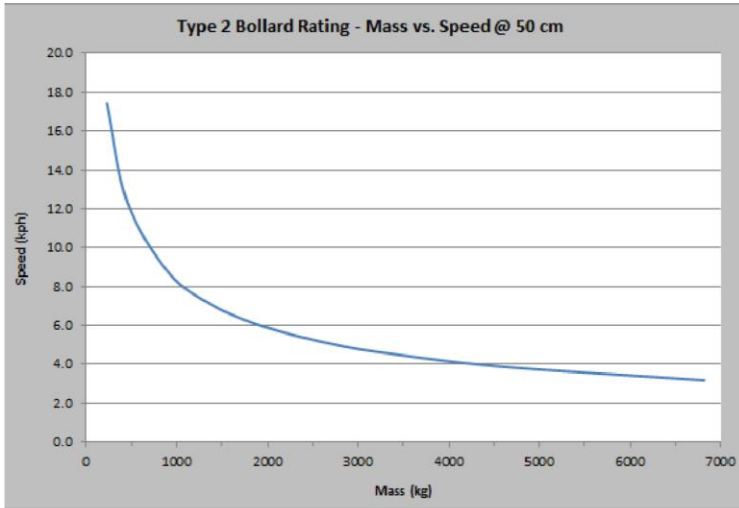

Installs with four (4)
Concrete Anchor Screws
(not included)

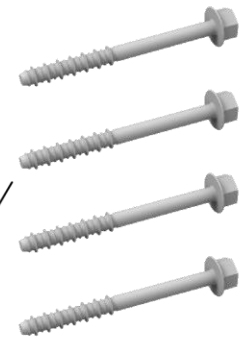

- Color: RAL 1023 Yellow Bollard on Black Base
- Diameter: 101.6mm (6,3 mm wall)
- Height: 100 cm
- Set Screws: 5 M16 x 2.00
8mm Hex
- Cap: Black Plastic

SPECIFICATIONS

- Energy Absorption: 2,667 joules
- Temperature Rating: -40°
- Pipe Coating: Galvanized + Polyester Powder Coat
- Base Coating: Environmentally Friendly Water-Based KTL Coating + Polyester Powder Coat

RECOMMENDED USES

- Equipment and Storage Rack Guarding
- Drive-Thru Lanes
- Utility Protection
- Pedestrian Safety
- Access Denial
- Fuel Pump Protection
- Structural Concrete Safe
- Not for Hostile Vehicle Security



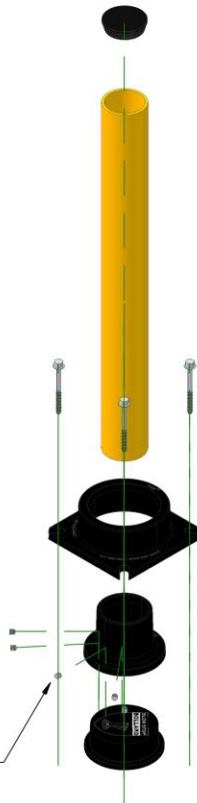
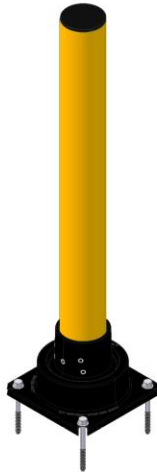
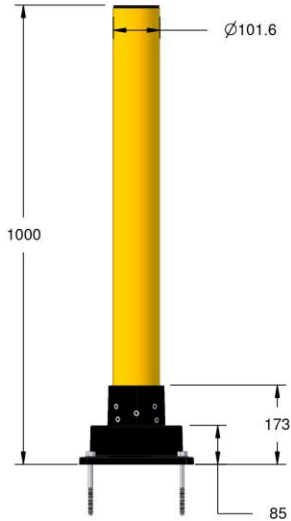

5 X M16-2MM
CUPPED SET SCREWS

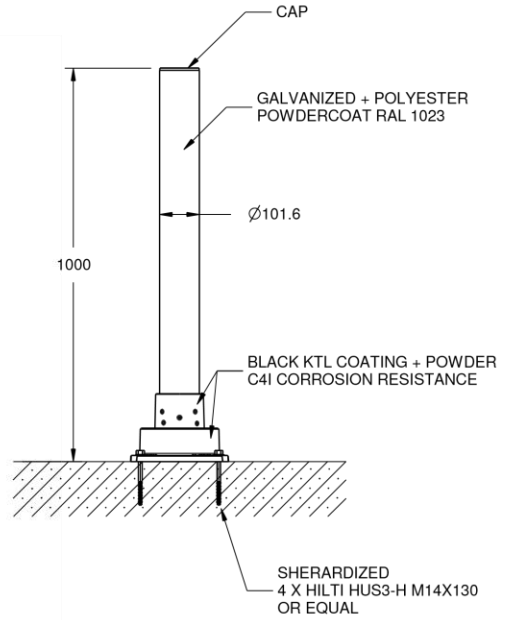

* MINIMUM FOUNDATION DEPENDS ON LOCAL SOIL CONDITIONS, WEATHER, & ENG REQ'TS



IMPACTrecovery
SYSTEMS
"Performance for a Safer Tomorrow"

CONFIDENTIAL & PROPRIETARY

The drawing on this print and the information therewith are property of Impact Recovery Systems, Inc., and shall not be used or discussed in whole or in part without the consent of Impact Recovery Systems, Inc.

4955 STOUT DR. · SAN ANTONIO, TX 78219 · (800) 736-5256

SIZE
A

PART NO.
SS-T2Y-100

DWG.
SLOWSTOP BOLLARD - TYPE 2 X 100CM

REV
1.0

SCALE

IMPACT RECOVERY SYSTEMS, INC.

DATE 25-MAR-2016